

HNG

Plug with o-ring for gearboxes

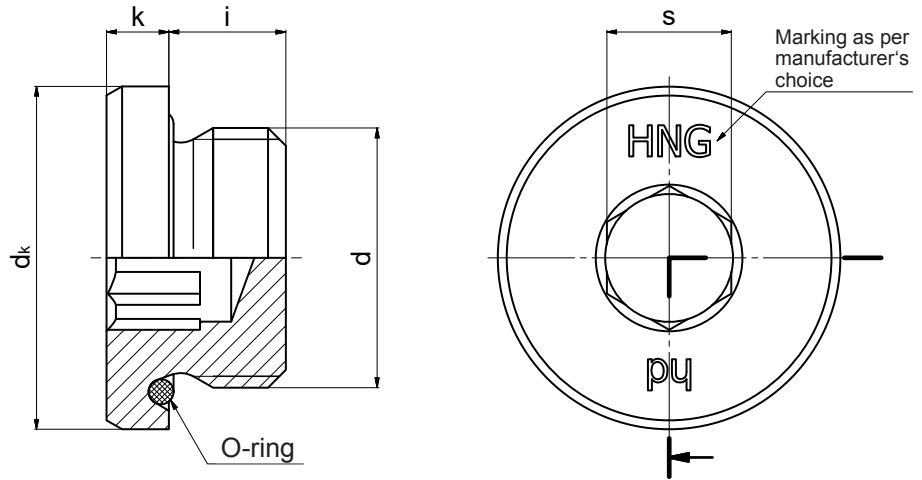

Application areas:

- Gearbox components
- Designed for an operating pressure between -0,09 MPa (-0,9 bar) and 1,6 MPa (16 bar)
- For counterbores as DIN 3852-1
- Can be loosened and tightened repeatedly

O-ring acc. DIN 3601:

- NBR 70 Shore -20°C to +120°C (-4 F to +248 F)
- FKM 80 Shore -20°C to +200°C (-4 F to +392 F)
- EPDM 70 Shore -50 to +200°C (-58 R to +392 F)
- Other temperature ranges upon request

Material:

- Steel 11SMnPb30+C (1.0718)
DIN EN 10277-3 ultrasonic and crack tested, or "HD-quality"
- Stainless steel 1.4305 / 1.4571
- Other materials upon request

Coating:

- Zinc-Nickel
- Other coatings upon request

d		k	dk	i	s	Weight
Metric fine thread						
DIN 13		±0,3	h14	±0,3	D12	~kg per 100 pieces
M10 x 1	—	3	14	5,5	5	0,46
M12 x 1,5	—	3	16	6,5	6	1,08
M14 x 1,5	—	3,5	19	7	8	1,13
M16 x 1,5	—	4	21	7,5	8	1,74
M18 x 1,5	—	4	24	8,5	10	2,03
M20 x 1,5	—	4	26	8,5	12	3,31
M22 x 1,5	—	4,5	27	9,5	14	3,21
M24 x 1,5	—	4,5	29	9,5	14	4,02
—	M27 x 2	4,5	33	9,5	17	4,63
—	M33 x 2	4,5	39	9,5	24	4,93
—	M42 x 2	5	49	10	30	9,25